

OPERATION MANUAL



RK-2006LPG2

Pellet fuel burner fitted boiler temperature controller.

Wersja 6A25

1. Application.

Controller RK-2006LPG2 is designed for temperature control of solid fuel fired water boilers equipped with:

- Auger and feeding stoker working with the stoker,
- Blow-in fan,
- Ignition glow plug for automatic start,
- Central heating pump,
- Hot tap water pump or mixing pump (option),
- Alarm indicator or ash removal system (option),
- Room thermostat (option).

2. Connection.

Before turning on the controller, connect: power cables of: controller, blow-in fan, central heating and hot tap water pumps and auger to appropriate sockets in the rear of the controller. The temperature sensor should be placed in metering locations that shall be dry. Figure 2 presents the electrical connection diagram. For connection of stoker, alarm indicator and ash removal system the additional module UM-1 shall be applied.

CAUTION! Before plugging in the controller first check if the wiring system is properly grounded, and if the terminal screws of the output connector are tightened.

CAUTION!Total power of the fan, central heating and hot water pump which are connected to the controller must not exceed 900W. Outputs of the controller that are not used may remain disconnected.

CAUTION! Control outputs of the feeder and lighter are not protected and **MUST BE** protected with adequate fuses.

CAUTION! The controller is equipped with properly protected semiconductor temperature sensors, yet metering locations with installed sensors must be dry.

3. Operation.

After power-up the controller displays the name and version of the software, then goes to the state it was in before shutting down or lose power.

On the front panel of the controller (Figure) there is:

- 1 – display,
- 2 – STOP button, reset the alarm and cancel the changes,
- 3 – START button and choose the parameter,
- 4 – the boiler thermostat knob and set the parameters and click OK,
- 5 – MENU button and choose the parameter,
- 6 – ESC / output.



Figure 1. Front panel of RK-2006LPG2 controller.

Basic operation of the device is to set the preset boiler temperature. In this hands? U need to turn the boiler thermostat knob (4) to set the correct value and confirm it with the OK button (or press the knob).

CAUTION! If you enter the room thermostat works in adaptive mode, you try to change the set temperature of the boiler may end in failure, ie. After approval of the new value of the controller can automatically change the boiler temperature to a value that results from the operation of the adaptive algorithm.

CAUTION! If the heating system has a water heater, the water temperature in the boiler maintained by the controller during the heating tray may be higher than the set temperature of the thermostat knob.

4. Overview of display symbols.

HOT WATER PATH
EXISTS

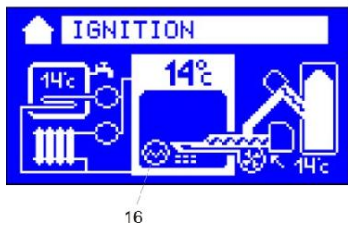
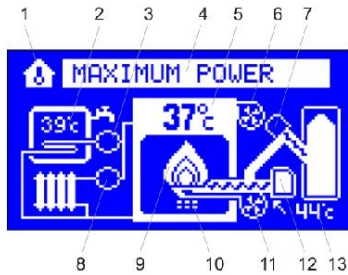

HOT WATER PATH
MIXING PUMP

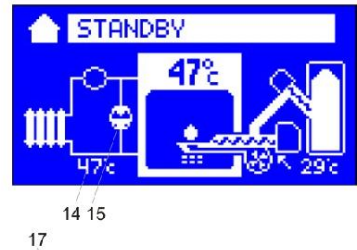

- 1 – Thermostat work indicator,
- 2 – DHW temperature,
- 3 – DHW pump work indicator,
- 4 – Controller work mode,
- 5 – Boiler water temperature,
- 6 – Additional fan,
- 7 – Feeder work indicator,
- 8 – CH pump work indicator,
- 9 – Burner capacity indicator (the higher the capacity, the brighter the flame),
- 10– Cleaning device work indicator,
- 11– Fan,
- 12– Stoker work indicator,
- 13– Feeder temperature,
- 14– Return water temperature,
- 15– Mixing pump work indicator,
- 16– Ignitor work indicator.
- 17– Emergency power system work indicator.

5. Device operation modes.

Table 1. Operation mode list.

Operation mode.	Description
STOP	Boiler control stopped. Controller maintains central heating and domestic water pump operation, but automatic ignition does not follow.
STAND-BY	Controller maintains central heating and domestic water pump operation. In case of heat demand automatic ignition of boiler follows.
IGNITION	Controller carries out automatic ignition of boiler.
STABILIZATION OF THE FIRING	Fan control and feeder so as to stabilize the the burner.
MAX. POWER	Fan and fuel feeder operates to reach boiler max. power.
MODUL. POWER	Controller reduces fuel feeding as much as boiler water temperature corresponds to the desired setting.
MINIMUM POWER	Fan and fuel feeder operation is minimize to maintain fire.
SCAVENGE (AIR PURGING)	Controller activates blower to ensure removal of accumulated gases.
AFTERBURNING	No demand for heat or furnace needs cleaning. The controller turns off the tray and burnout of fuel until the flame failure.
EXTINCTION	The controller suppresses the boiler furnace.
CLEANING	Burner cleaning.
AUGER (MANUAL) REFILLING	Manual operation of fuel auger. Boiler control stopped. Controller maintains central heating and domestic water pumps operation, but automatic ignition does not follow.
AUGER EXTINGT (EMERGENCY SHUT DOWN)	Fuel ignition in auger channel. The controller empties ignited fuel from the auger channel until temperature drops.
ALARMS	Safety and temperatures sensors failure alarms.

STOP.

Controller maintains central heating and domestic water pumps operation only to protect the boiler against overheating and auger channel ignition. Room thermostat contacts closing(call for heat) and domestic water temperature drop do not result in any action. Pressing START button will result in switching the controller to STAND-BY mode.

STAND-BY.

In this mode controller does not carry out any additional operation, until room thermostat contacts close (call for heat) or domestic water temperature drop, the boiler operation will focus on maintenance of temperature according to thermostat setting programmed with the knob. If preheating of domestic water tank is necessary and the desired boiler temperature setting is higher from domestic water temperature setting the controller will follow higher setting. Pressing the STOP button () will result in switching to STOP mode.

IGNITION.

Boiler controller is switched into IGNITION mode if demand for heat follows, and if the controller did not detect the flame. During ignition the controller activates fan, auger and igniter. Fuel and air feeding rate is adjusted by the technician. IGNITION

mode follows till flame is detected. If the flame is not detected within the specified time, the controller activates „Out of fuel alarm”. Pressing STOP button, exceeding time limit for cleaning, thermostat contacts opening or if water temperature in domestic water tank is obtained during operation in IGNITION mode will result in switching of the controller into EXTINCTION (SHUT DOWN) mode.

Stabilization of the firing.

Boiler burner is switched to the stabilization of the detected flame ignition. While stabilizing the fan runs at a speed the same as when operating in maximum power. Tray gives fuel quantity such as the minimum power. In addition, depending on the service settings fuel dose may be increased gradually. Stabilization of the firing continues for the time programmed in the settings of the service or until the boiler temperature. Pressing the STOP button, exceeding the working time without cleaning, opening the contacts of the thermostat or to achieve the required water temperature in the hot water tank during operation stabilization ignition, the controller will switch to after-burning mode.

CAUTION! Stabilization of ignition can be turned off by a service technician. In this case, after the fire the controller switches to work with maximum power.

MAX. POWER OPERATION MODE.

When in this mode the controller operates fuel auger and fan to ensure max. power of the boiler. Fuel and air feeding rate is adjusted by the technician. Pressing STOP button, exceeding time limit for cleaning, thermostat contacts opening or if water temperature in domestic water tank is obtained during operation in MAX. POWER mode will result in switching of the controller into EXTINCTION (SHUT DOWN) mode.

MODULATED POWER OPERATION MODE.

Depending on desired parameters the controller may gradually reduce fuel and air rate feeding to reduce burner power, as much as boiler water temperature corresponds to the programmed setting. Pressing STOP button, exceeding time limit for cleaning, thermostat contacts opening or if water temperature in domestic water tank is obtained during operation in MODULATED POWER mode will result in switching of the controller into EXTINCTION (SHUT DOWN) mode.

MINIMUM POWER OPERATION MODE.

When in this mode the controller operates fuel feeding and fan operation to maintain firing to ensure the minimum fuel consumption. Fuel and air feeding rate is adjusted by the technician. If in spite of boiler minimum power, increase temperature follows of water temperature in relation to the top hysteresis parameter setting, the controller will be switched into EXTINCTION(SHUT DOWN) mode. When the boiler water temperature drops below the desired setting it will result in switching of the controller into „max power operation mode”. Pressing STOP button, exceeding time limit for cleaning, thermostat contacts opening or if water temperature in domestic water tank is obtained during operation in MINIMUM POWER mode will result in switching of the controller into EXTINCTION (SHUT DOWN) mode.

SCAVENGE (AIR PURGING).

During the operation with minimum power output, the controller will activate flue scavenge (purging) to ensure removal of accumulated gases. Scavenge (purging) is provided with temporary fan operation in higher speed.

EXTINCTION (SHUT DOWN).

When in this mode the controller turns off the fuel auger and engages the fan to ensure complete fuel combustion and the burner cool down. Fan power when in EXTINCTION (SHUT DOWN) mode is determined by the technician. When EXTINCTION (SHUT DOWN) is finished the controller is switched into CLEANING, STAND-BY or STOP mode, provided EXTINCTION (SHUT DOWN) followed as a result of STOP button pressing.

Blanking mode.

In this mode, the controller changes the fan speed on the value programmed by a service technician to burn off excess fuel and cool the burner. After putting out the fire controller switches to CLEANING, ARMED or STOP depending on what caused the start of the sequence Afterburning EXTINCTION.

CLEANING.

Automatic burner cleaning occurs after time set limit by programmer. In this mode controller starts cleaning system for preset time. After this procedure controller resets back to STANDBY mode.

AUGER (MANUAL) REFILLING.

User may activate auger manual refilling function. When device is in STOP mode, press START and hold button for 5 seconds to start refilling. Refilling follows according to the time programmed by the technician or until it is manually turned off with STOP button.

AUGER EXTINCTION (EMERGENCY SHUT DOWN).

If the auger is equipped with a temperature sensor, a temperature increase above the range programmed by the technician, it will result in activation of auger ignition alarm. The controller turns off the fan and auger. If the burner is equipped with the stoker, the device is switched additionally into AUGER EXTINCTION(EMERGENCY SHUT DOWN) mode. During shut down the stoker is engaged for the time needed to remove the ignited fuel from the stoker. In addition if the burner has cleaning mechanism, the controller will activate the cleaning cycle and remove fuel from the burner.

ALARMS.

RK-2006LPG2 controller continually checks operations of installed devices as well as alarm sensors. In case of failure, the device activates alarm and proper operations are carried out. Information on the problem is also shown on the display. In addition depending on nature of damage the inner sound alarm system may be activated. To cancel alarm, first identify the cause and repair it and then STOP button shall be pressed. If alarm is cancelled and required repairs did not follow, sound alarm system will be turned off only. In case more than one alarm has been activated, information on each alarm will be displayed alternately.

Out of fuel alarm.

If in IGNITION mode the controller fails to detect a flame within the time specified by the technician, „Out of fuel alarm” will be activated. To turn on the controller again first refill fuel, cancel the alarm with STOP button and begin setting-up process by pressing START button.

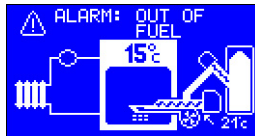

Emergency alarm.

Depending on construction type, the boiler may be equipped with emergency sensor (e.g. hopper cover sensor). Activation of the alarm will result in fan and auger turning off, and switching the controller into STAND-BY mode.

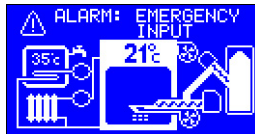

CAUTION! This alarm does not result in engagement of inner sound system and does not require cancelling. Once the hopper cover is closed, the programmed process will be carried out from the moment when it was interrupted (it returns to the mode that was before alarm activation).

Auger ignition alarm.

If the auger has been equipped with a temperature sensor, and the programmed setting of „Auger ignition temperature" was exceeded, it will result in activation of auger ignition alarm. The controller will go to SHUT DOWN mode.

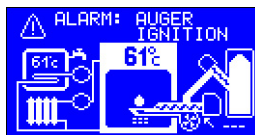

CAUTION! This alarm may be cancelled only if the auger temperature drops below set point. If the alarm was cancelled before extinction completion, only sound alarm will be turned off.

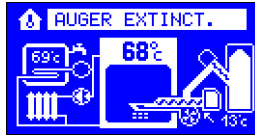

Auger sensor damage.

In case of auger temperature sensor damage, as in case of overheating, the controller will go to shut down mode and will activate the appropriate alarm:

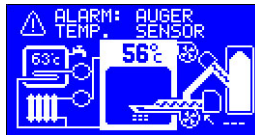

CAUTION! This alarm may be cancelled only after repairs.

Burner temperature sensor damage.

If flame temperature detector (CT-1/2 or PT-1000) has been connected to the controller, its damage will result in activation of the alarm and switching into STAND-BY mode.

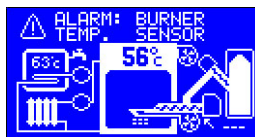

Protection against overheating and overheating of the boiler.

RK-2006LPG is protected against overheating of the boiler. If the water temperature reaches a preset value in parameter TEMP service. MAXIMUM THE BOILER, the controller activates the pump absolutely CO. The increase in water temperature in the boiler to the value programmed in parameter service TEMPERATURE BOILER OVERHEAT will turn off the fan, heating pump, switch the controller to STOP mode without starting the process of extinction and trigger the alarm:

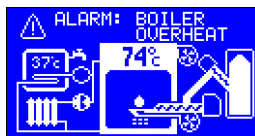

CAUTION! This alarm may be cancelled, if boiler water temperature drops below the overheating temperature setting.

Boiler temperature sensor damage.

In case of boiler water temperature sensor damage the controller turns off the fan, engages central heating pump, controller switches into STOP mode and activates alarm:

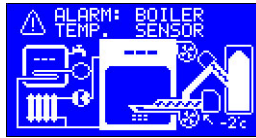

CAUTION! This alarm may be cancelled, only if repairs are made.

Domestic water temperature sensor damage.

If the heating system is fitted with domestic water circuit, in case of sensor damage the controller turns off the domestic water pump and activates alarm:

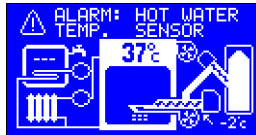

CAUTION! This alarm does not require cancellation. The alarm is deactivated automatically, if repairs are made.

Return water temperature sensor damage.

If the heating system is provided with the mixing pump, in case of return water temperature sensor damage, the pump is switched off and the controller activates alarm:

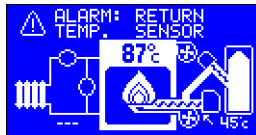

CAUTION! This alarm does not require cancellation. The alarm is deactivated automatically, if repairs are made.

6. Preview and set user parameters.

Pressing the MENU button we can view the following user parameters.

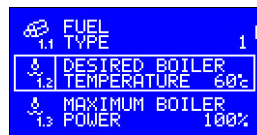
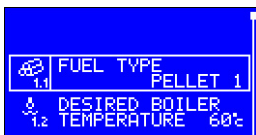

The user can switch between different parameters by turning the knob (4). By pressing the knob you enter the mode of change of the selected parameter – the parameter will be backlit. You can change the value of the selected parameter by turning the knob. To confirm the change press the knob again, and the controller will return to the list of parameters. To leave the mode of change and restore the previous value of a parameter, press the MENU or ESC button. If the device is left either in the changing or viewing the parameters mode for 60 seconds, removal of the modification introduced recently and switching in the mode of displaying the device status will occur automatically.

Table 2. User settings list.

L.p	Parameter	Min	Max
1.1	Fuel type.	1	4
1.2	Desired boiler temperature.	40°C	90°C
1.3	Boiler max. power.	60%	100%
1.4	Central heating pump operation mode.	WINTER	SUMMER
1.5	Domestic water desired temperature.	30°C	60°C
1.6	Domestic water heating priority.	NO	YES
1.7	Domestic water tank bacterial flora liquidation program.	NO	YES
1.8	Measured domestic water temperature.		
1.9	Measured return water temperature.		
1.13	Current furnace brightness (FD-1).		
1.14	Ignitor turn-off depending on the illuminance value.	0	255
1.10	Temperature of the burner (PT-1000, CT-1/2).		
1.11	Ignitor turn-off depending on the temperature.	200°C	500°C
1.15	Burner running time.		
1.16	Number of inflammation burner.		
1.17	Boiler is turned on.	NO	YES
1.18	DHW heating is turned on.	NO	YES
1.19	Alarms cancellation.		
1.20	Burner working mode. (CYCLIC, CONTINUOUS, CONTINUOUS PLUS).		

1.1 Fuel type selection.

RK-2006LPG controller enables programming ignition settings for four different fuel types. „Fuel type” parameter enables switching between particular settings. Fan, auger and igniter operation are saved for the selected fuel type. PELLET 1,2,3 and WOOD. When the WOOD fuel is set, you can burn the wood in the pellet boiler – the controller operates at the wood fuel burning settings. WOOD/PELLET – once the wood has been burned, the controller switches to pellet burning and full service to the pellet boiler is provided.

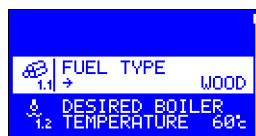
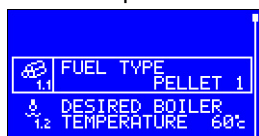

CAUTION! Fuel type may be changed, if the controller is in STOP mode only.

1.2 Desired boiler temperature – it is the temperature setting that will be obtained by the controller, if room thermostat input contacts are closed.

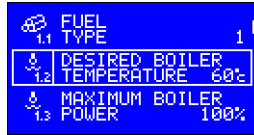

1.3 Boiler operation max. power.

Boiler operation max. power – this parameter enables to limit boiler operation max power. Power limitation is possible thanks to fuel reduction during operation at maximum power.



1.4 CH pump work mode – WINTER/SUMMER – you can turn off the heating during summer by selecting the SUMMER value. The parameter indicates the CH pump work will be turned off. When in the mode, the regulator controls the boiler to feed the domestic hot water circulation only.

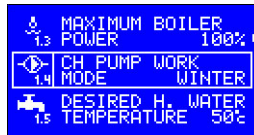

1.5 Domestic water desired temperature – parameter that specifies temperature of water in domestic water tank that will be obtained by the controller.

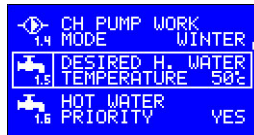

1.6 Domestic water heating priority – this parameter specifies operation of central heating and domestic water pumps during hot water preheating. When priority is selected during operation and hot water preheating, the controller engages domestic water pump and switches off central heating pump. This operation results in quick heating of water in the tank. During preparation of hot water without priority option, central heating and domestic water pumps operation follow at the same time.

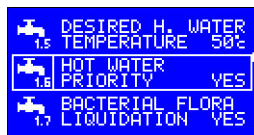

1.7 Bacterial flora liquidation in domestic water tank – the controller enables manual activation of program for bacterial flora liquidation in domestic water tank. When „YES” is selected, it activates the process of heating the domestic water tank above 75°C. When the required temperature is obtained the controller switches off the bacterial flora liquidation program automatically.

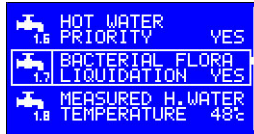

CAUTION! Bacterial flora liquidation option shall be switched on in the night or if water intake does not follow from the domestic water tank, to protect the user against burning.

1.8 Domestic water measured temperature – the controller enables to view the temperature measured in domestic water tank.

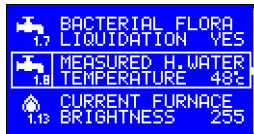

CAUTION! In case the heating system is not fitted with the DHW circuit, it is not possible to view or change the above parameters.

1.9 Return water temperature.

If the heating circuit is equipped with the mixing pump and return temperature sensor, this option enables view of the return water temperature. Otherwise, this option is unavailable.

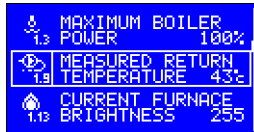

Flame optical detection parameters.

These parameters specify operation of burner flame optical detector. If the system is fitted with flame temperature detector, parameters change and viewing is unavailable.

1.13 The current furnace brightness determined by an optical detector – this parameter displays the current flame brightness measured by the optical detector.

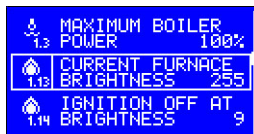

1.14 Brightness when fuel ignition has occurred – if the optical detector reading will be equal or higher than this desired setting, the controller will switch off the igniter and assume that ignition has occurred.

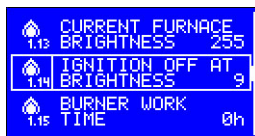

Flame detection temperature parameters.

These parameters specify operation of the temperature detector of burner fuel ignition. If the system is fitted with optical fire burner detector, parameters change and viewing is unavailable.

1.10 Burner measured temperature – this parameter displays the current measured burner temperature.

1.11/1.12 Burner temperature with fuel ignited – if ignition temperature is equal or higher than this desired setting, the controller will switch off the lighter and assume that ignition was provided.

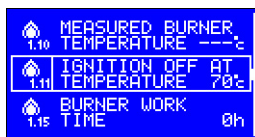

Information on burner work.

Parameters described below refer to counters that accumulate information on operation of the burner since its first start. It is not possible to cancel counter readings.

1.15 Burner work time – reading of this counter defines burner work time. The counter updating follows after total working hour of the device at maximum or minimum power.

1.16 Burner start up counter – reading of this counter defines start number of the ignition attempts.

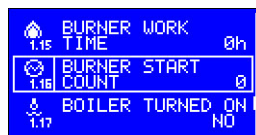
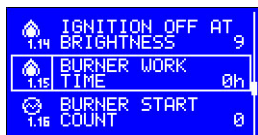

1.17 Boiler on – the parameter informs the user if the boiler is turned on and allows him/her to turn it on or off.

1.18 DHW heating on – the parameter informs the user if the DHW heating is turned on and allows him/her to turn it on or off.

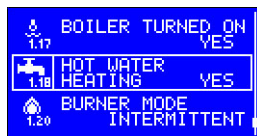
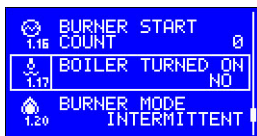

1.19 Alarms cancellation – the parameter enables the user to cancel the alarms recorded in the controller data storage.

1.20 Burner mode.

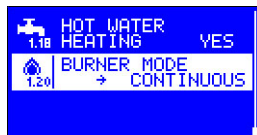
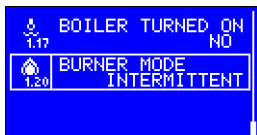

CYCLIC – turning off the thermostat will cause the controller to switch into the POSTCOMBUSTION mode.

CONSTANT – once the thermostat is turned off, the controller will switch into the MINIMUM CAPACITY mode instead of the POSTCOMBUSTION (the mode saving the ignitor).

CONTINUOUS PLUS – the burner is continuously turned on (except from emergencies) and ignites and heats up automatically even when the contacts of the thermostat are opened (unlike the continuous mode, when contacts of the thermostat should be closed to heat up the burner).

7. Setting the parameters – service mode.

Service parameters are divided into groups. For each group are assigned service parameters possible to change. Entry into service mode after press and hold for about 3 seconds the MENU button. regulator displays a list of service parameters possible to edit and change.



Viewing the list of parameters is possible by turning the multifunction knob - possible to edit the parameter is highlighted. After selecting the desired parameter press the OK button (knob), and enter the subgroups of a given parameter. Select the parameter you want to change and press the knob - a parameter is highlighted. Turning the knob set the desired value and then press the knob. Giving up mode changes and restore the previous value of the parameter by pressing the STOP button or ESC. If the unit is left in a mode change or view the parameters for 60 seconds, the controller will automatically withdraw the recently introduced modification and switch to display the status of the device. A list of all service parameters presented in the table. The table columns contain the following order: group number, name of the parameter and the value of the minimum and maximum possible settings.

Table 3. Table service parameter.

Lp.	Parametr	Min	Max
2.x Overall	2.1 Language. (see description)).		
	2.2 Brightness of the display.		
	2.3 Saturation.		
	2.4 Contrast.		
	2.5 Service settings.	NO	YES
	2.7 Output testing.	NO	YES
3.x Fan	3.1 Fan modulation during boiler start.	NO	YES
	3.2 Min. fan speed during heating up.	1%	100%
	3.3 Max. fan speed during heating up.	1%	100%
	3.4 Ignition modulation start delay.	0s	250s
	3.5 Fan speed during ignition.	1%	100%
	3.6 Fan speed at max. power.	1%	100%
	3.7 Fan speed at min. power.	1%	100%
	3.8 Fan speed at extinction.	1%	100%
	3.9 Fan speed during cleaning mode.	0%	100%
	3.10 Fan scavenge (air purging).	NO	YES
	3.11 Fan scavenge (air purging) blow time.	5s	60s
	3.12 Fan scavenge (air purging) pause time.	1min	99min
	3.13 Fan speed during scavenge.	1%	100%
4.x Auger	4.1 Auger filling tim.	1min	99min
	4.2 Initial fuel feed.	0s	250s
	4.3 Fuel feed cycle.	1s	250s
	4.4 Fuel feed during ignition.	0%	100%
	4.5 Fuel feed for max burner power.	1%	100%
	4.6 Fuel feed for min. burner power.	1%	100%
	4.7 Stoker work mode (See description).		
	4.8 Stoker work time.	1s	99s
	4.9 Stoker pause time.	1s	99s
	4.10 Stoker extra work time.	1s	99s
	4.11 Stoker emptying time.	1s	99s
	4.12 Auger ignition test.	NO	YES
	4.13 Auger ignition temperature.	20°C	99°C
5.x Igniter	5.1 Flame detector type: FD-1, PT-1000, CT-1/2.		
	5.2 Correction FD-1.	0	99
	5.3 Hysteresis loss of flame (temperature sensor).	1°C	250°C
	5.4 Hysteresis loss of flame (optical sensor).	1	255
	5.5 Flame failure detection delay.	1s	500s
	5.6 Fuel ignition timea.	1min	15min
	5.7 Ignition try count.	1	10
	5.10 Firing stabilization.	NO	YES
	5.11 Stabilization time firing up.	1min	99min
	5.12 Smooth stabilization firing.	1min	99min
	5.13 The blanking time the furnace.	1min	30min
	5.15 Blower at pellet burning mode.		
	5.16 Blower at the wood burning mode.		
6.x Cleaning mechanism	6.1 Mode of operation of the cleaning mechanism: CYCLE, ROTO, AUTO, COMBI, COMBI2		
	6.2 Cleaning mechanism work time.	1s	900s
	6.3 Cleaning mechanism retraction time.	1s	900s
	6.4 Cleaning mechanism pause time.	1s	900s
	6.5 Opening time cleaning mechanism.	1s	900s
	6.6 Closing time cleaning mechanism.	1s	900s
	6.7 Number shut downs before cleaning.	1	99

	6.8 Minimum operating time without cleaning.	0h	max-1h
	6.9 Maximum working time without cleaning.	min+1h	99h
	6.10 Reversing the cleaning mechanism.	NO	YES
7.x CH pump	7.1 Central heating pump work mode: TERM, AUTO.		
	7.2 Periodic turning on the CH pump.	NO	YES
	7.4 Duration of the CH pump cyclic work.	1min	99min
	7.3 Interval duration in the CH pump operation.	1min	99min
8.x HTW pump	8.1 Domestic water path: OFF, ON, MIXING PUMP,		
	8.2 Domestic water heating hysteresis.	1°C	20°C
	8.3 Boiler increase temperature during hot tap water heating.	2°C	20°C
	8.4 Domestic pump work extension.	NO	YES
	8.5 Domestic pump work extension time.	1min	10min
	8.6 Stabilization time.	1min	99min
	8.7 Mixing pump engaging temperature.	30°C	60°C
	8.8 Mixing pump work hysteresis.	1°C	9°C
	8.9 Heating up the boiler for DHW.	NO	YES
9.x Thermostat	9.1 Boiler minimum temperature.	30°C	69°C
	9.2 Boiler maximum temperatur.	70°C	90°C
	9.3 Boiler upper hysteresis.	1°C	20°C
	9.4 Boiler power switching hysteresis.	1°C	9°C
	9.5 Boiler protection hysteresis.	1°C	5°C
	9.6 Boiler overheating temperature.	90°C	99°C
	9.7 Burner power modulation.	NO	YES
	9.8 Modulation factor.	1	20
	9.9 The operating mode of the thermostat: NORM, ADAP.		
	9.10 The time constant adaptation.	1min	99min
	9.11 Burner off delay.	0min	99min
10.x Data transmission	10.1 Data link: (see description). OFF, MODBUS RTU.		
	10.2 MODBUS device number.	1	247
	10.3 MODBUS channel capacity: 2400, 3600, 4800, 7200, 9600, 14400, 19200, 28800,38400, 56000, 57600, 76800, 115200.		
	10.4 MODBUS frame format: 8N1,8E1, 801, 8N2.		
	10.5 MODBUS access level: NONE, READOUT, USER's, SERVICE.		
	10.6 Terminal access level: NONE, READOUT, USER's, SERVICE.		
11.x Fan 2	11.1 Blower 2; ON, NONE.		
	11.2 Modulation of blower speed rate at ignition.	NO	YES
	11.3 Minimum blower speed at ignition.	1%	100%
	11.4 Maximum blower speed at ignition.	1%	100%
	11.5 Modulation turn-on latency at ignition.	0s	250s
	11.7 Blower speed rate at the maximum capacity.	1%	100%
	11.8 Blower speed rate at the minimum capacity.	1%	100%
	11.9 Blower speed rate at extinction.	1%	100%
	11.10 Blower speed at cleaning.	1	247
	11.11 Blower draught.	NO	YES
	11.12 Draught duration.	5s	60s
	11.13 Silence between draughts duration.	1min	99min
	11.14 Blower speed at draught.	1%	100%
	12.x Emergency power system	12.1 Power supply malfunction control: NONE,ON.	
12.2 Turn-off latency.		NO	YES
12.3 Power supply shortage mode: POSTCOMBUSTION, CLEANING			
12.4 CH pump work		NO	YES
12.5 DHW pump work		NO	YES

2.x Overall.

2.1 Language selection.

RK-2006LPG2 controller interface offer the function of language selection. Number of available languages depend on software version being used.



2.2–2.4 Brightness, saturation, contrast of the display.

The parameters enable the user to adjust the display to his/her own needs.

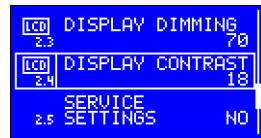

2.5 Service settings – setting and confirm with the OK button to display the value YES when this option will delete all the parameters and assign them to the pre-programmed by the installer or service technician.

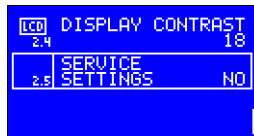

2.7 Testing out.

In order to verify the correctness of the controller, it is possible to test various output devices. This feature is available in service mode only if the adjustment process is stopped, ie. The regulator before entering the service mode was in STOP mode. Selecting output testing allows the control knob to select the outputs on the display. Pressing OK allows you to temporarily attach the selected output. In order to complete the testing procedures exit, press the STOP button.

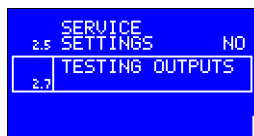

3.x Fan operation parameters.

3.1 Fan modulation during boiler start – selection of „YES” setting means that fan speed modulation will be provided during boiler start.

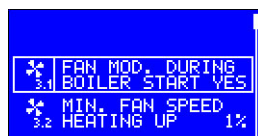

3.2 Min. fan speed during heating up – this parameter is available, if the function of fan modulation during boiler start is selected. This parameter specifies power of the fan during boiler start.

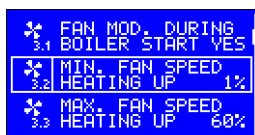

3.3 Max. fan speed during heating up – this parameter is available, if the function of fan modulation during boiler start is selected. This parameter specifies power of the fan at end of boiler start.

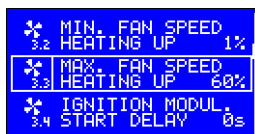

3.4 Ignition modulation start delay – this parameter is available, if the function of fan modulation during boiler start is selected and it describes operation time of the fan with speed according to the selected „Min. fan speed during boiler start” setting. After time expire the controller will increase fan speed up to the selected „Max. fan speed during boiler start” setting.

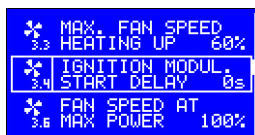

3.5 Fan speed during ignition – this parameter describes power of the fan speed during ignition. This parameter is unavailable if „Fan speed modulation during ignition” was selected.

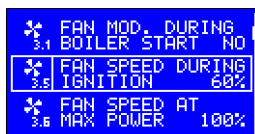

3.6 Fan speed at max. power – means the fan power when burner of the boiler works with maximum power.

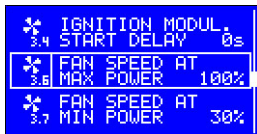

3.7 Fan speed at min. power – means the fan power when burner of the boiler works with minimum power.

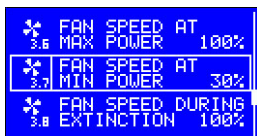

3.8 Fan speed during extinction (shut down) – means fan power during burner extinction (shut down).

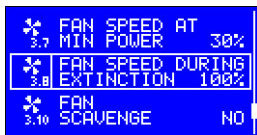

3.9 The fan speed for cleaning – this parameter is available only when the cleaning mechanism operates in AUTO mode or COMBI. It specifies that the power of the fan while cleaning the hearth.

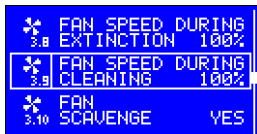

3.10 Fan scavenge (air purging) – the controller offers the function of scavenge (air purging), which simply includes periodical switching on of the fan during burner operation for the purpose of removal of accumulated gases.

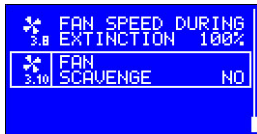

3.11 Fan scavenge (air purging) blow time – this parameter specifies blow time. This setting is unavailable if „Fan scavenge” (air purging) setting was not selected.

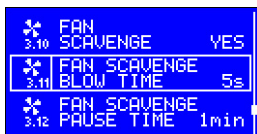

3.12 Fan scavenge (air purging) pause time – this parameter specifies pause time during scavenge. This setting is unavailable if „Fan scavenge” (air purging) setting was not selected.

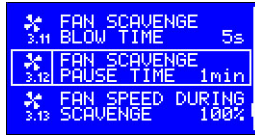

3.13 Fan speed during scavenge (air purging) – this parameter specifies fan power during scavenge (air purging). This setting is unavailable if „Fan scavenge” (air purging) setting was not selected.

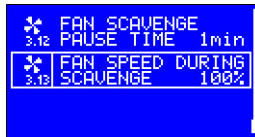

4.x Fuel auger operation parameters.

4.1 Auger filling time – this parameter specifies time required for refilling the main auger with fuel.

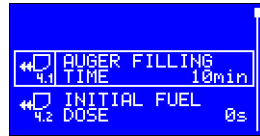

4.2 Initial fuel feed – this parameter specifies time, when fuel will be fed before igniter start. Selection of „0s” setting will switch off initial fuel dose feeding. In this case „Fuel dose during ignition” setting shall be programmed as the value over „0%”.

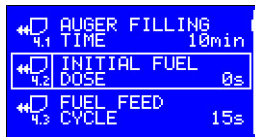

4.3 Fuel feed cycle – auger operation cycle includes fuel feeding and feeding pause. This parameter specifies the time of the whole cycle. The desired value specifies all burner work modes which require fuel feeding (ignition, maximum and minimum power).

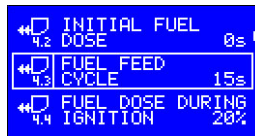

4.4 Fuel feed during ignition – this parameter specifies fuel dose that is fed to the burner during lighter operation. The programmed setting specifies feeding time in percent in relation to the time of whole work cycle. Selection of „0s” setting will switch fuel feeding during operation of the lighter. In this case „Initial Fuel Dose” setting be shall be programmed as the value over „0s”.

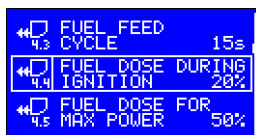

4.5 Fuel feed for max. burner power – this parameter specifies fuel dose fed to the burner during operation with maximum power. The programmed setting specifies feeding time in percent in relation to the time of whole work cycle.

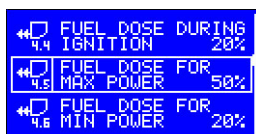

4.6 Fuel feed for min. burner power – this parameter specifies fuel dose fed to the burner during operation with minimum power. The programmed setting specifies feeding time in percent in relation to the time of whole work cycle.

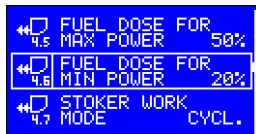

4.7 Stoker work mode – This parameter defines the operation of the internal tray (stoker):

OFF – the burner without the stoker.

CYCL – stoker is switched on periodically, regardless of the auger. Work and pause time of the stoker is determined with particular settings.

AUTO – operation mode when the stoke is switched on along with the auger and is switched off with a delay defined with „Stoker extra work time” setting.

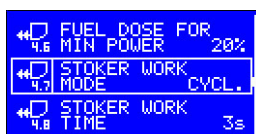

4.8 Stoker work time – this parameter specifies operation time of the stoker in whole work cycle. This setting is unavailable if the stoker is switched off or in automatic mode.



4.9 Stoker pause time – this parameter specifies pause time during stoker operation when in work cycle. This setting is unavailable if the stoker is switched off or in automatic mode.

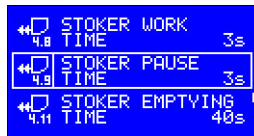

4.10 Time to extend the work stoker – this parameter is only available when stker is in automatic mode and determines how long after you turn off the main tray will work stoker.



4.11 Stoker emptying time – this parameter specifies time needed for removal of the whole fuel from the stoker. Stoker emptying during extinguishing of feeder, feeding initial fuel dose (portion), and during burner shut down. This setting is unavailable if the stoker is switched off.

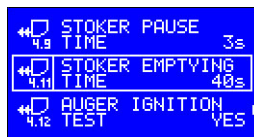

4.12 Auger ignition test – this parameter provides functionalities of „X” emergency input. If „NO” setting was selected then „X” input will be used for connection of e.g. auger flap opening contact sensor or the contact informing on operation of auger motor overload switch. If „YES” setting was selected then „X” input will be used for connection of auger temperature sensor used for ignition detection.

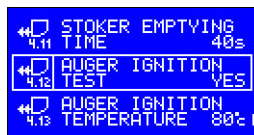

CAUTION! In case emergency input is not used, „NO” parameter shall be selected in „Auger ignition test” setting and contacts of „X” input shall be closed.

4.13 Auger ignition temperature – this parameter specifies auger temperature, when the controller activates auger ignition alarm. This parameter is unavailable when „NO” was selected in „Auger ignition test” setting.

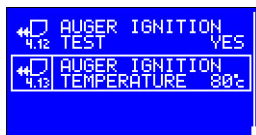

5.x Ignitor working parameters.

5.1 Flame detector type – FD-1/ CT-1/2/ PT-1000 – flame detection may follow with two methods: burner temperature measurement or brightness measurement. In case when temperature sensor is used, depending on its location, temperature measurement range may be from several degrees to several hundred degrees. If measured temperatures do not exceed 100°C it is recommended to use CT-1 or CT-2 sensor. In case of higher temperatures, PT-1000 sensor shall be used. For flame brightness measurement, FD-1 optical detector shall be used.

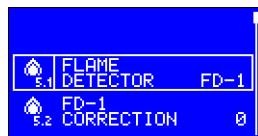

5.2 Indication correction of flame optical detector – only when flame optical detector (FD-1) is on. Describes light intensity detected by optical detector when burner is off. The correction value is deducted from the value light intensity during the flame detection. Correction allows calibration of FD-1 sensor the way that during burner shut down value (no flame) of the light equals zero.

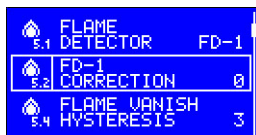

5.3–5.4 Hysteresis loss of flame – depending on the type of flame detector, this parameter specifies how many degrees or units in relation to the threshold set by the user must cut off the lighter or the brightness of the flame temperature to the controller began to flame failure detection procedure.

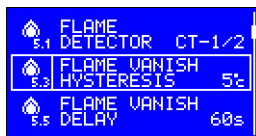

WARNING! If the hysteresis is larger than the threshold of igniter shut down, flame failure detection procedure is started when the temperature drops or the brightness of the flame to the value of „0”.

5.5 Flame failure detection delay – this parameter specifies how long after the launch procedures for the detection of flame failure or brightness temperature must remain below the hysteresis for the regulator to decide that the furnace was extinguished.

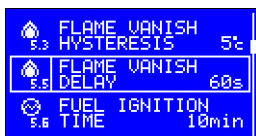

5.6 Fuel ignition time – after igniter and fan are switched on, the controller tests temperature increase or brightness in the selected location of the burner. If flame is not detected within the time programmed in this parameter, the controller will repeat ignition cycle.

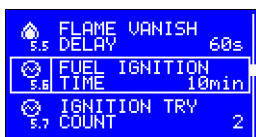

5.7 Ignition try count – this parameter specifies how many times ignition may fail until the controller activates „Out of fuel alarm” and switches into STOP mode. The alarm is indicated with adequate message displayed on the display. To start the controller first refill the fuel, then cancel by pressing STOP button and start setting mode by pressing START button.

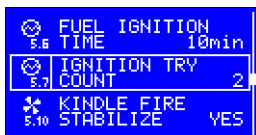

5.10 Firing stabilization – this parameter determines whether the fuel kindling Stabilization mode is enabled firing.

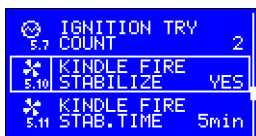

5.11 Firing stabilization time – this parameter determines the maximum operating time of stabilization firing. This parameter is not available if the parameter STABILIZATION OF FIRING is set to NO.

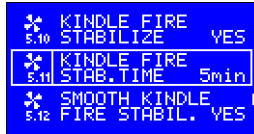

5.12 Smooth stabilization of ignition – setting the parameter to YES will cause the stabilization of firing up the controller gradually increases the amount of fuel fed. This parameter is not available if the parameter STABILIZATION OF FIRING is set to NO.

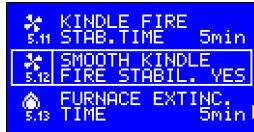

5.13 Furnace extinction (shut down) time – if the controller switches to extinction (shut down) mode, the induction fan is activated according to power selected in „Fan speed at extinction (shut down)” setting. After burner extinction (flame loss), the fan operation follows according to time programmed in this setting. This function ensures combustion of all fuel remains and burner cool down.

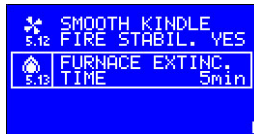

5.15 Blower at pellet burning mode – the parameter enables the user to switch an additional blower.

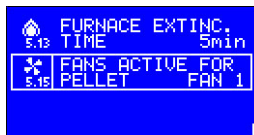

5.16 Blower at the wood burning mode – the user can determine which blower will be operating when the wood will be burned. You can select either the blower 1 or an additional blower 2, or both.

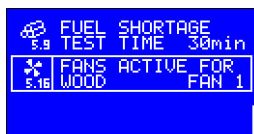

6.x Cleaning mechanism.

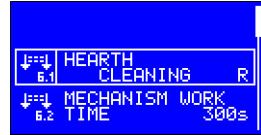

6.1 Furnace cleaning mode – this parameter specifies the way the cleaning mechanism works:

NONE – means that the burner does not have a cleaning mechanism. In this case, the output DATA is working as an external alarm.

CYCL – means the mode in which the cleaning procedure is run after the firing and repeated at regular intervals until burner shut down is completed. Cleaning procedure is attached to the time set in parameter „Cleaning mechanism work time“. After turning off the regulator, output deducts the time set in parameter „Cleaning mechanism retraction time" and the time set in parameter „Cleaning mechanism pause time".

ROTO – working mechanism ROTO mode is similar to mode CYCLE. The difference is that the control output cleaning mechanism is attached for the duration of the mode blanked.

AUTO – means the cleaning procedure is started automatically after a specified number shut downs or after a sufficient burner operation time. Automatic cleaning means: burner shut down and start cleaning mechanism for the time set in parameter „Cleaning mechanism work time".

After turning off the regulator, output deducts the time set in parameter "Cleaning mechanism retraction time" and then goes to normal working cycle.

COMBI – This mode is a combination of modes AUTO CYCLE. Working mechanism starts at the end of the firing and stabilization is cyclical switching mechanism for the time set in the parameter TIME WORK MECHANISM. After switching off the cleaning mechanism controller counts down the time set in parameter RETURN TIME MECHANISM, and the time set in parameter TIME PARKING MECHANISM. During operation the output EXTINCTION cleaning mechanism is disabled. After a certain number of extinctions or sufficient time, the burner is started automatically cleaning involving extinguished hearth, start cleaning mechanism at the time set in the parameter TIME OPENING THE MECHANISM and run the fan with the power specified in the parameter SPEED FAN. THE CLEANING.

After switching off the engine output controller also disables the fan and counts time set in the parameter TIME CLOSING MECHANISM, then take a normal job.

COMBI 2 – a mode similar to COMBI; the difference is that when the clearing device is turned on, the blower always operates with the capacity programmed in the parameter BLOWER SPEED RATE AT CLEANING, regardless of the current stage of operations (except emergencies).

6.2 Cleaning mechanism work time – this parameter is available only when the cleaning mechanism is activated (CYCLE, ROTO or COMBI. mode). It defines the time needed to complete the full mechanism to open or move to end position.

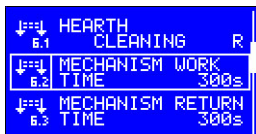

6.3 Cleaning mechanism retraction time – this parameter is available only when the cleaning mechanism is activated (CYCLE, ROTO or COMBI. mode). It specifies the time required for the mechanism retraction to the rest position after turning off the control output.

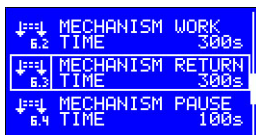

6.4 Cleaning mechanism pause time – this parameter is available only when the cleaning mechanism is activated (CYCLE, ROTO or COMBI. mode). It specifies the time interval between successive repetition of the cleaning cycle.

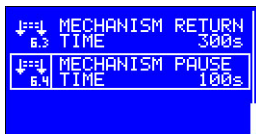

6.5 Opening time cleaning mechanism – this parameter is only available when cleaning mechanism operates in AUTO mode or ESTATE and determines the time required to complete the opening mechanism during cleaning automatic.

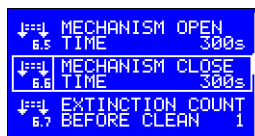
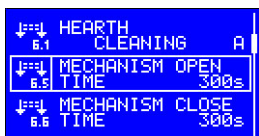

6.6 Closing time cleaning mechanism – This parameter is available only when the cleaning mechanism operates in AUTO mode or COMBI and determines the time it takes to return the mechanism to its rest position after the full opening of the automatic cleaning mechanism.

6.7 Number of extinctions before cleaning – this parameter is available only when the cleaning mechanism operates in AUTO mode or COMBI and determines which in turn goes off to start the procedure of cleaning.

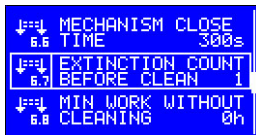

6.8 Minimum operating time without cleaning – this parameter is available only when the cleaning mechanism operates in AUTO or COMBI mode. Specifies the minimum number of hours the burner must in order to start cleaning. If the minimum time is not reached, the cleaning will not run even if there was a required number of shut downs. Setting the parameter to „0h" control the minimum time off work without cleaning.

6.9 The maximum working time without cleaning – this parameter is available only when the cleaning mechanism operates in AUTO or COMBI mode. Specifies how many hours the burner can work without cleaning. If the maximum time is reached, the cleaning will run even if there was no required number of shut downs.

6.10 Reversing the cleaning mechanism (default: NO) – setting the parameter to YES results in reversing the exit work of the cleaning mechanism. With the parameter on, the power supply is turned on continuously to allow the mechanism exit, and it is turned off during the mechanism operation. When the system is equipped with an actuator, the parameter allows the change in the direction of the mechanism operation.

7.x Central heating pump work parameters.

7.1 Central heating pump switching on parameters – this parameter specifies the method of central heating pump switching on. Selection of „THERMOSTAT" setting means that central heating pump will be switched on only if room thermostat contacts are closed and in case of emergency (e.g. boiler overheating). Selection of „AUTO" setting means that central heating pump operation will follow regardless of room thermostat.

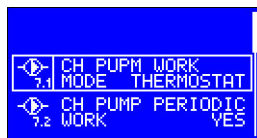
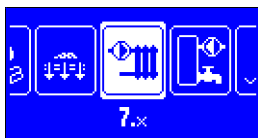

7.2 Periodic turning on the CH pump – the parameter enables the option of turning the CH pump occasionally to mix the water in the heating circuit. The pump is turned on for the duration defined in the parameter TIME DURATION of CH PUMP WORK. The option is available when the CH pump mode of work has been set to the value TERM.

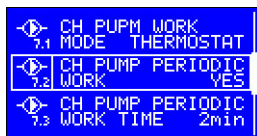

7.4 Duration of the CH pump cyclic work – the programmed value defines the duration of the CH pump operation when the thermostat contacts are opened. The parameter is available only when the CH pump works in the TERM mode and the option of periodic turning on the CH pump is on.

7.3 Interval duration in the CH pump operation – the programmed value defines the interval duration between consecutive CH pump turn-ons. The parameter is available only when the CH pump works in the TERM mode and the option of turning on the CH pump is on.

8.x Setting domestic water pump parameters – NO, IS, Mixing pump

The controller offers an additional function for heating of domestic water. Not every heating system is provided with domestic water tank and charge pump, this circuit may be switched off or used for control of the pump that mixes the return water in the boiler.

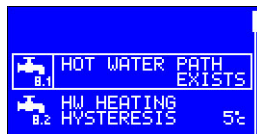

8.1 Domestic water path – if „NONE” is selected the domestic water pump is off. In this case temperature sensor input and pump control output may remain disconnected. Selection of „EXISTS” setting provides for interlock release of all parameters and functions related to domestic water path handling. Election of „MIXING PUMP” setting will switch domestic water in the circuit purposed for control of the mixing pump. In this case return water temperature sensor shall be connected instead of domestic water sensor, and the mixing pump instead of charge pump of domestic water tank.

8.2 Domestic water heating hysteresis – this parameter indicates water temperature drop in the tank in relation to the programmed setting (so that charge pump was switched on). This setting is available, if domestic water path „EXISTS” setting was selected.

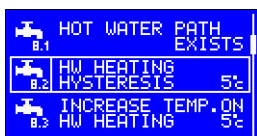

8.3 Increase temperature during domestic water heating – Closing thermostat contacts means that boiler operation will follow according to the temperature programmed with the thermostat knob. If domestic water tank heating is necessary, the desired boiler temperature is higher in relation to the desired domestic water by the selected value in this setting. In case of simultaneous operation of the room thermostat and domestic water tank heating, the controller operation will follow to maintain the higher boiler temperature. This setting is available, if domestic water path „EXISTS” setting was selected.

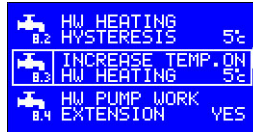

8.4 Domestic water pump work extension – quick switching off of the pump refilling domestic water tank may result in excessive rise of boiler temperature. This parameter enables switching on of domestic water pump extension. This setting is available, if domestic water path „EXISTS” setting was selected.

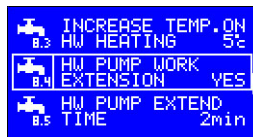

8.5 Domestic water pump extension time – this parameter specifies the time lapse when domestic water is switched off since the moment when the programmed temperature of domestic water tank was obtained. This setting is available, if domestic water path „EXISTS” setting was selected and pump extension was selected.

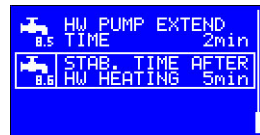
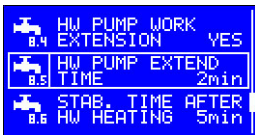

8.6 The stabilization time after heating hot water – during the preparation of hot water priority enabled all the power boiler is used to heat water. Temperature of the boiler during operation for hot water is often higher than the required heating circuit. In addition, the CH pump off when working with hot water priority can cause hypothermia heated rooms and a room thermostat input activation. In this case, after working for the hot water boiler water temperature may be higher than the temperature required to heat the rooms. This may result in extinction of the burner due to exceeding the hysteresis top of the boiler. This parameter specifies how long is needed to stabilize the system after the hot water tank with priority enabled. During the stabilization controller disable checking hysteresis top and suspend the operation of the adaptive algorithm of the room thermostat. This parameter is available only when hot water is on track.

CAUTION! This feature does not work if water preparation is done without priority or the controller is in summer mode.

8.7 Mixing pump engaging temperature – this parameter specifies required return water temperature so that the mixing pump engagement follows the controller. This parameter is available if domestic water path „MIXING PUMP” setting was selected.

8.8 Mixing pump work hysteresis – this parameter specifies required return water temperature increase in relation to the mixing pump engagement temperature so that the controller switches off the mixing pump. This parameter is available if domestic water path „MIXING PUMP” setting was selected.

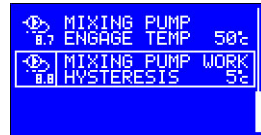
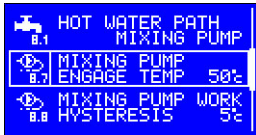

8.9 Heating up the boiler for DHW – when the parameter is set to 'OFF', the controller does not start to heat up the DHW until contacts of the thermostat input are closed.

9.x Boiler work parameters.

9.1 Minimum boiler temperature – this parameter specifies boiler temperature when the controller shall switch off central heating and domestic water pumps. It is the lowest temperature setting of the boiler that can be programmed with thermostat's knob.

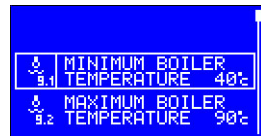

9.2 Maximum boiler temperature – this parameter specifies boiler max. programmed temperature setting which can be programmed with thermostat's knob. It is also boiler temperature when central heating pump is engaged to provide protection for the boiler against overheating.

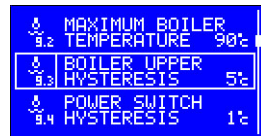
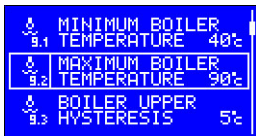

9.3 Boiler upper hysteresis – if the controller works in burner minimum power mode, and boiler temperature increase follows by this programmed setting, the controller will start burner extinction(shut down).

9.4 Burner power switching hysteresis – when the programmed boiler water temperature is obtained the controller is switched to minimum power work mode. This parameter specifies required water temperature drop so that maximum power work mode was activated. After switching to maximum power the fuel and air feeding dose is determined according to burner power modulation.

▲	BOILER UPPER	
9.3	HYSTERESIS	5%
▲	POWER SWITCH	
9.4	HYSTERESIS	1%
▲	BOILER PROTECT.	
9.5	HYSTERESIS	2%

9.5 Boiler protection hysteresis – the controller provides for boiler minimum and maximum temperature by providing control over operation of central heating and domestic water pumps. This parameter specifies hysteresis parameter of boiler limit temperatures switching off.

▲	POWER SWITCH	
9.4	HYSTERESIS	1%
▲	BOILER PROTECT.	
9.5	HYSTERESIS	2%
▲	BOILER OVERHEAT	
9.6	TEMPERATURE	98%

9.6 Boiler overheating temperature – this parameter specifies boiler water temperature when the controller switches off control and activates boiler overheating alarm.

▲	BOILER PROTECT.	
9.5	HYSTERESIS	2%
▲	BOILER OVERHEAT	
9.6	TEMPERATURE	98%
✱	POWER	
9.7	MODULATION	YES

9.7 Burner power modulation – when modulation is switched on it will results in gradual reduction of fan speed and fuel dose to obtain boiler water temperature corresponding to the programmed setting.

▲	BOILER OVERHEAT	
9.6	TEMPERATURE	98%
✱	POWER	
9.7	MODULATION	YES
✱	MODULATION	
9.8	FACTOR	5

9.8 Burner power modulation factor – this parameter specifies degree setting when the controller will reduce burner power before boiler water temperature is obtained according to the programmed setting. Burner power is reduced by gradual reduction of fed fuel dose and fan speed reduction. This parameter is unavailable, if burner modulation power is off.

✱	POWER	
9.7	MODULATION	YES
✱	MODULATION	
9.8	FACTOR	5
###	THERMOSTAT WORK	
9.9	MODE	NORMAL

The room thermostat.

RK-2006LPG2 was equipped with an input for connecting any room thermostat with contact output. Contacts of the thermostat is signaled by the appearance of the thermometer symbol in the index of the thermostat.

CAUTION! The entrance of the room thermostat is active only during WINTER. Lights up when the input state is independent of the mode setting.

9.9 Mode of operation of the room thermostat – this parameter determines the impact of the entry of the room thermostat to the operation of the controller:

NORM. – in this mode, the thermostat contacts are closed when the controller starts firing up the burner and the boiler strives to maintain the set temperature of the boiler thermostat knob. After reaching the desired temperature in the room and the thermostat regulator contacts open burner extinguishes and goes STANDBY.

ADAP. – in this mode, the controller analyzes the changes in the thermostat input and based on automatically determines the setpoint temperature of the boiler.

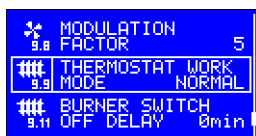

Caution! In the case of not using the room thermostat input should remain closed, and the operation of the thermostat set to the NORM .. In this case, the boiler will operate continuously maintaining the set temperature of the boiler thermostat knob.

9.10 The time constant of adaptation – this parameter is available when the thermostat is working in adaptive mode. It determines the rate of "seeking" appropriate adaptive algorithm preset boiler temperature. Value should be selected empirically according to the characteristics of the controlled object. If you are working adaptive algorithm and frequently changing external conditions we observe frequent overheating of the rooms, increase the time constant. During niedogrzewania value should be reduced.

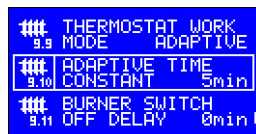

9.11 Burner off delay – this parameter determines the time of the burner in minimum power the thermostat contacts open. If, after the programmed time the thermostat input will not be closed again, the torch will be lit, and the controller switches to STANDBY. Setting this parameter to 0 minutes will immediately extinguish the torch after contact opening thermostat.

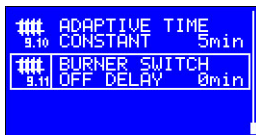

CAUTION! If the controller works well for hot water, the burner after contact opening the thermostat can be switched off after a time other than that programmed in the parameter.

10.x Data transmission.

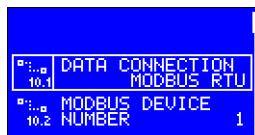

10.1 Data link – the parameter allows the user to select the operation performed by the data connector.

NONE – connector inactive (default value).

MODBUS RTU – Communication by RS-485 bus with using the ModBus standard RTU protocol.

10.2 MODBUS device number – 1..247 – allows the user to determine the number of the device attributed to your controller, and to avoid errors when a number of devices are switched to the bus. Default value -1.

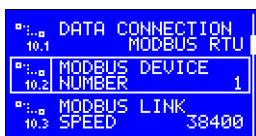

10.3 MODBUS channel capacity – selection of the RS-485 transmission speed. Default value – 38400.

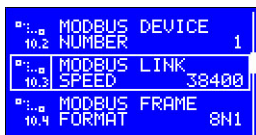

10.4 MODBUS frame format – allows you to determine the data frame format used in the RS- 485 transmission.

8N1 – 8 bits of data, no parity bits, 1 bit of silence.

8E1 – 8 bits of data, even parity bit, 1 bit of silence.

8O1 – 8 bits of data, odd parity bit, 1 bit of silence.

8N2 – 8 bits of data, no parity bits, 2 bits of silence (default setting).

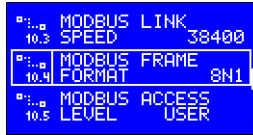

10.5 MODBUS access level – defines to what extent the configuration of parameters is available to the ModBus protocol.

NONE – no parameters are provided by the controller.

READ-OUT – the controller allows you to view its parameters only.

USER – changing the user’s parameters only is available (default setting).

SERVICE – changing all of the parameters is possible.

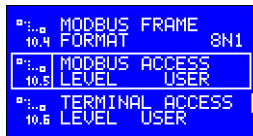

10.6 Terminal access level – defines to what extent access can be obtained through the remote terminal.

NO – no access through the remote terminal.

READ-OUT – terminal allows you to view the parameters and controller work only.

USER – it is possible to change the parameters user’s settings (default settings).

SERVICE – full access to the controller and viewing all of the parameters can be obtained through the terminal.

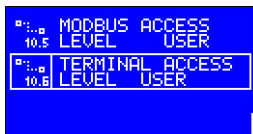

10.7 Additional delay –Controller response delay.

11.x Additional blower.

11.1 Blower 2 – to use an additional blower, change value of the parameter to ON.

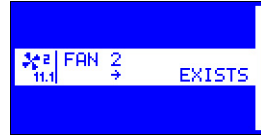
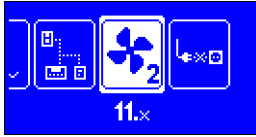

12.x Emergency power system.

Power supply malfunction control – to ensure continuity of work, the controller has been equipped with the power supply malfunction control. When the power system has been equipped with uninterruptible power supply and the power supply malfunction detector, the controller will switch to uninterruptible power supply when malfunction occurs.

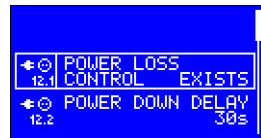

12.2 Turn-off latency – is the period after which (when power supply malfunction occurs) the controller will switch into the emergency mode and will be not responsive to short-lived power supply malfunctions.

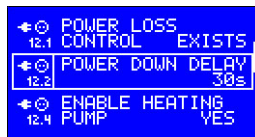

12.3 Power supply shortage mode – POSTCOMBUSTION, CLEANING – when the controller has switched to the emergency mode, it will start cleaning or postcombustion and cleaning processes after the period set in TURN-OFF LATENCY parameter.

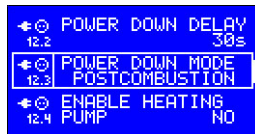

12.4 CH pump work – the parameter defines, if the CH pump will work in the emergency mode.

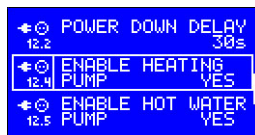

12.5 DHW pump work – the parameter defines, if the DHW pump will work in the emergency mode.

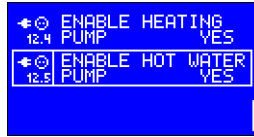

12.6 Mixing pump work – the parameter defines, if the mixing pump will work in the emergency mode.

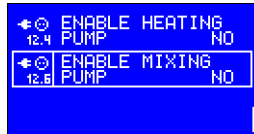

4. DATA emergency output – audible alarm or cleaning mechanism.

The regulator has output [D] allows you to connect via the UM-1 module siren alarm or additional cleaning mechanism. If you exit this mode, the siren is in alarm, it is activated in the event of: sensor failure of the boiler, burner sensor, the sensor or mixing pump hot water, boiler overheating or lack of fuel.

5. Controller disassembly.

If controller disassembly is necessary follow the following procedure:

- Disconnect the boiler and controller from power supply,
- Remove the controller from the boiler,
- Disconnect terminals and wires from the controller.

6. Technical Data.

Power Supply	230 V ± 10%, 50 Hz
Power consumption (without fan and pump)	< 4 VA
Burner temperature measurement range (KTY 81-210)	-9–109°C±1°C
Temperature measurement range (KTY 81-210)	-9–109°C±1°C
Burner temperature measurement range (PT-1000)	-30–500°C±3°C
Boiler temperature adjustment range	30–90°C±1°C
Boiler programmed overheating protection	90–99°C±1°C
Boiler equipment overheating protection	>95°C±1°C
Total outputs rating	max 4 A / 230 V
Dimensions (H x W x D)	96 x 144 x 94

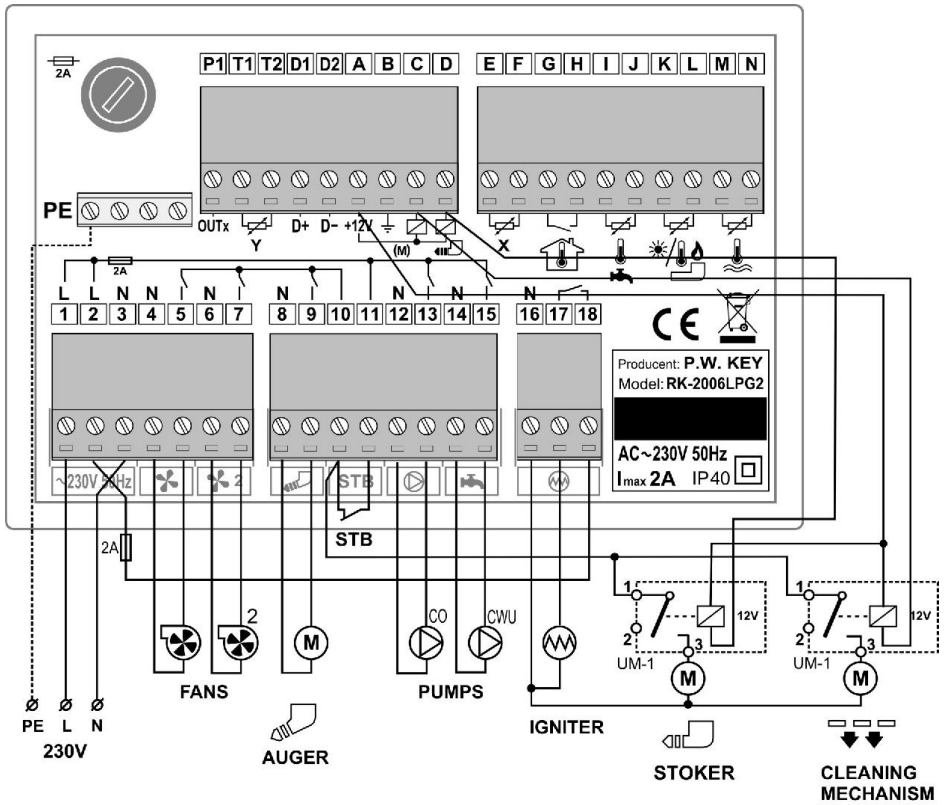

Figure 2. RK-2006LPG2 Controller connection diagram.

DECLARATION OF CONFORMITY

Manufacturer:Przedsiębiorstwo Wielobranżowe KEY
11-200 Bartoszyce, ul. Bohaterów Warszawy 67

hereby declares that the product:

RK-2006LPG2 Controller

the essential requirements of
EC directive on electrical equipment for use within
certain voltage limits 2014/35 / UE (LDV) from 02/26/2014
and the

EC Electromagnetic Compatibility Directive 2014/30 / UE
equivalent (EMC) from 26.02.2016.

Applied harmonized standards:

EN 60730-1:2000 (PN-EN 60730-1:2002)
EN 60730-2-9:2010 (PN-EN 60730-2-9:2011)
EN 61000-3-2:2006 (PN-EN 61000-3-2:2007)
EN 61000-3-3:2008 (PN-EN 61000-3-3:2011)
EN 55022:2010 (PN-EN 55022:2011)

mgr inż. Zdzisław Kluczek

właściciel

Information on disposal

This appliance is marked according to the European Directive 2002/96/EC on Waste Electrical and Electronic Equipment (WEEE).



The symbol on the product, or the documents accompanying the product, indicates that his appliance may not be treated as household waste.

The appliance shall be handed over to the applicable collection point for used up electrical and electronic equipment for recycling purpose.

Ultimate disposal of the appliance shall follow according to applicable local regulations on waste utilization. For more information about disposal, utilization and recycling please contact your local authorities, household waste disposal service or the shop where you purchased the product.

Manufacturer: Przedsiębiorstwo Wielobranżowe KEY
11-200 Bartoszyce, ul. Bohaterów Warszawy 67
tel. (89) 763 50 50, fax. (89) 763 50 51
www.pwkey.pl e-mail: pwkey@onet.pl